

SMD Power Inductors For Automotive Size 3015B

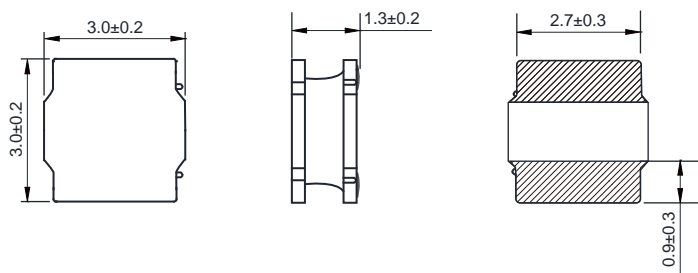

Dimensions: [mm]



Land Pattern: [mm]

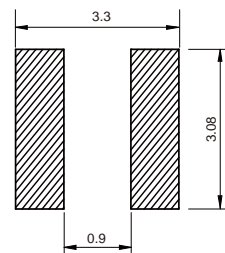

Electrical Properties:

| Part No | Inductance @ 100KHz/1V | Tolerance | Temperature Rise Current Typ. (A) | Temperature Rise Current Max. (A) | Current Typ. (A) | Current Max. (A) | DC Resistance ±20% |
|---------|------------------------|-----------|-----------------------------------|-----------------------------------|------------------|------------------|--------------------|
| | ? | ? | | | | | |
| | ? | ? | | | | | |
| | ? | | | | | | 33 |
| | ? | | | | | | |
| | ? | | | | | | |
| | ? | | | | | | |
| | ? | | | | | | |
| | ? | | | | | | |

Saturation Current will cause L to drop approximately 30%

Temperature Rise Current: The actual value of DC current when the temperature rise is $\Delta T=40^{\circ}\text{C}$

Typical Electrical Characteristics:

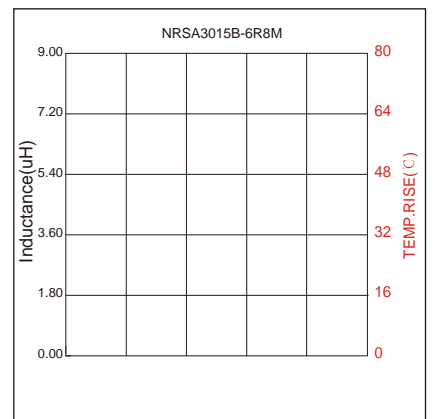
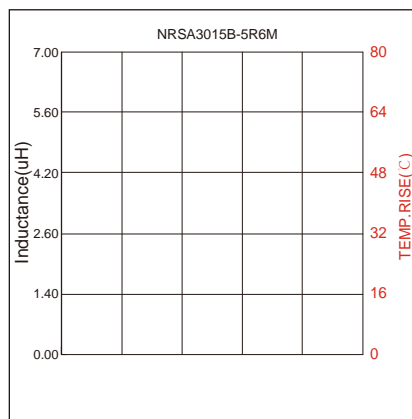
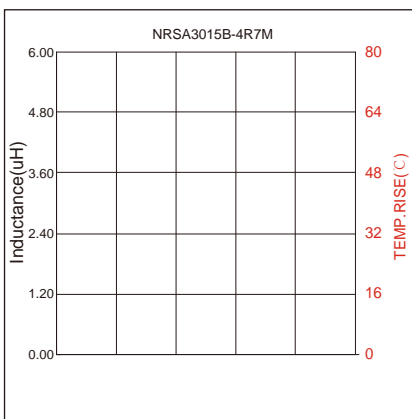
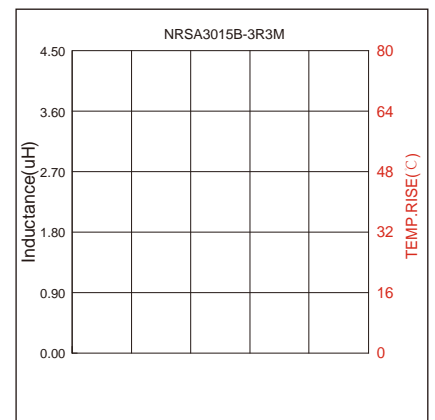
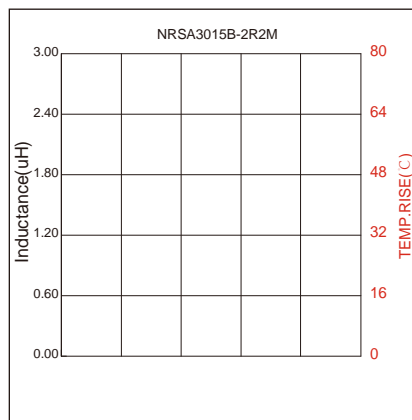
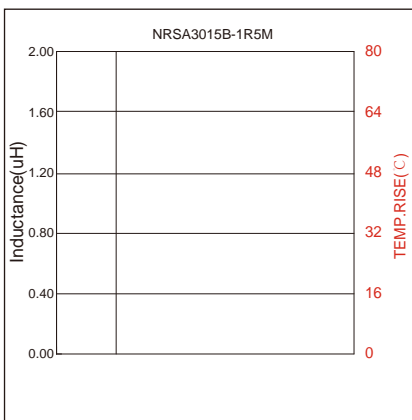
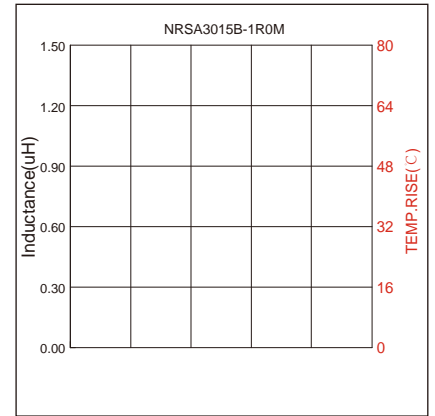
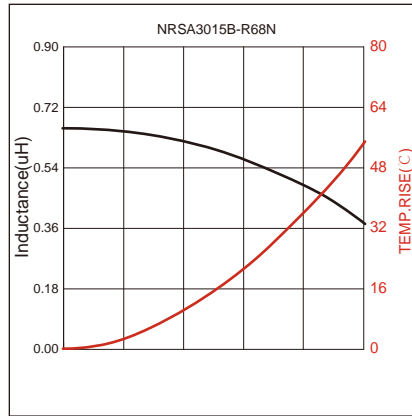
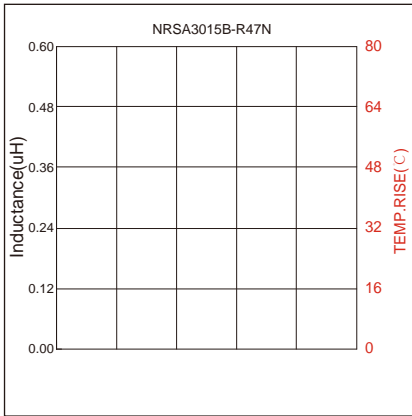

Soldering Reflow:

Packaging Information:

Tape Dimension :

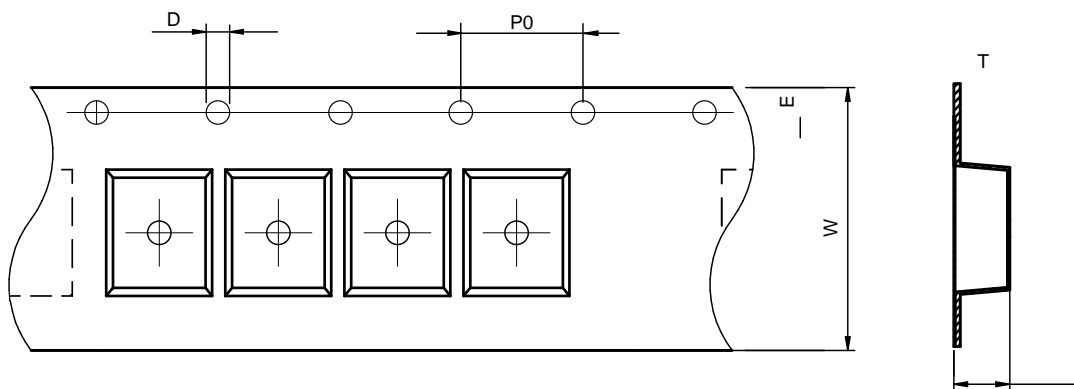

| Series | A0 (mm) | B0 (mm) | D (mm) | P0 (mm) | P1 (mm) | W (mm) | K0 (mm) | E (mm) | T (mm) |
|-----------|---------------|---------------|---------------|---------------|---------------|---------------|---------------|----------------|-----------------|
| NRSA3015B | 3.2 ± 0.1 | 3.2 ± 0.1 | 1.5 ± 0.1 | 4.0 ± 0.1 | 4.0 ± 0.1 | 8.0 ± 0.3 | 1.7 ± 0.1 | 1.75 ± 0.1 | 0.30 ± 0.05 |

Peel force of top cover tape:

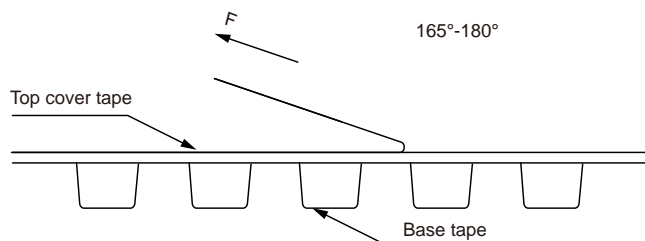

The peel force of top cover tape shall be between 0.3 to 1.17 N

Reel Dimension: [mm]

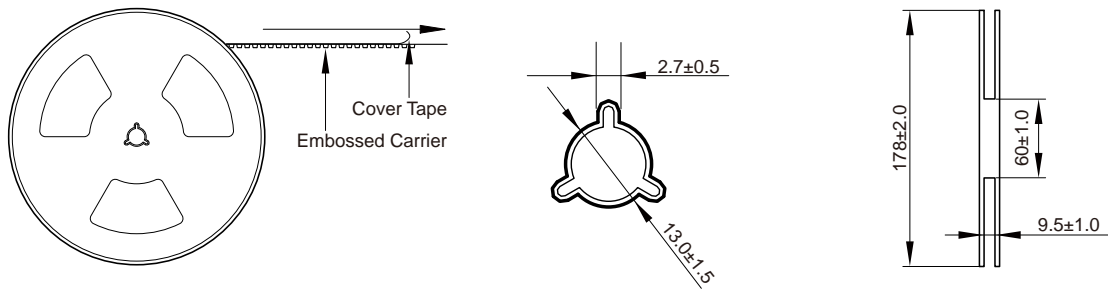

Packaging Quantity:

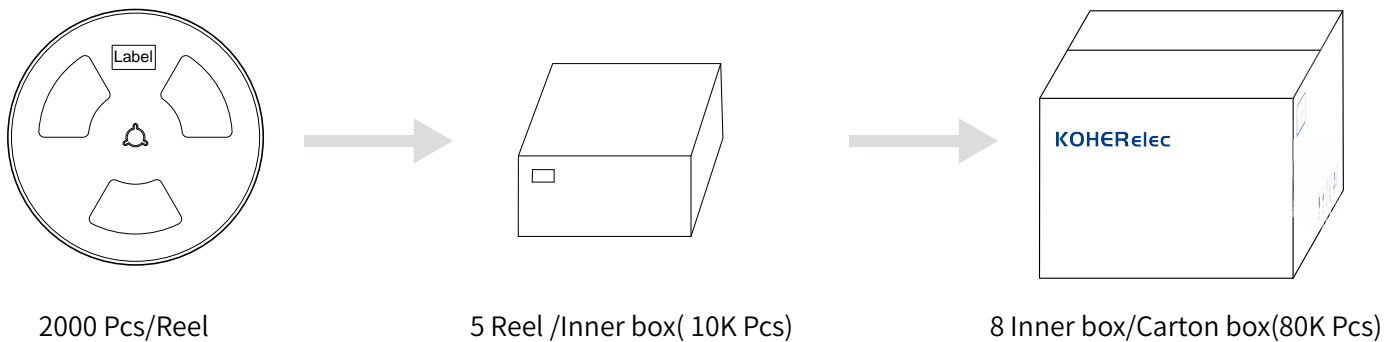

Cautions and Warnings:

Storage Conditions :

- The storage period is within 12 months after the completion of production. Be sure to follow the storage conditions (temperature: -5 to 35°C, humidity: 75% RH Max).If the storage period elapses, the soldering of the terminal electrodes may deteriorate.The warranty period is one year.
- Product should not be exposed to environment with high temperature, high humidity, dust, corrosive gas and etc.
- Products should be handled with care to avoid damage or contamination from perspiration and skin oils.
- Please always handle products carefully to prevent any damage caused by dropping down or inappropriate removing.

Operation Instructions:

- Self heating (temperature increase) occurs when the power is turned ON, so the tolerance should be sufficient for the set thermal design.
- Before soldering, be sure to preheat components.The preheating temperature should be set so that the temperature difference between the solder temperature and chip temperature does not exceed 150°C.
- Soldering corrections after mounting should be within the range of the conditions determined in the specifications.If overheated, a short circuit, performance deterioration, or lifespan shortening may occur.
- Generally, Koher might not be familiar with either customer's specific application or actual requests as customer does.As a result customer shall be responsible for checking and confirming whether Koher product with the performance described in the product specification is suitable for using in customer's particular application or not.