



**FBHA Series**  
**Chip Ferrite Bead High Current Type**  
**Size 0805**

**FEATURES**

- 
- 
- 
- 
- 
- 
- 
- 



**APPLICATION**

- 

**Dimensions: [mm]**

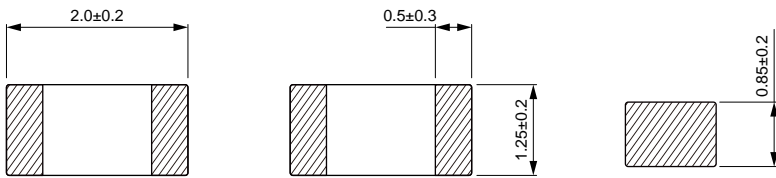

**Land Pattern: [mm]**

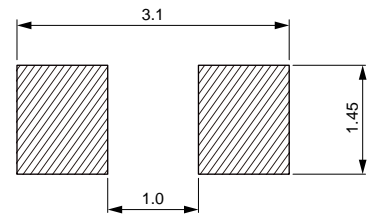

**Electrical Properties:**

Temperature Rise Current: The actual value of DC current when the temperature rise is  $\Delta T=40^{\circ}\text{C}$



## Typical Electrical Characteristics:

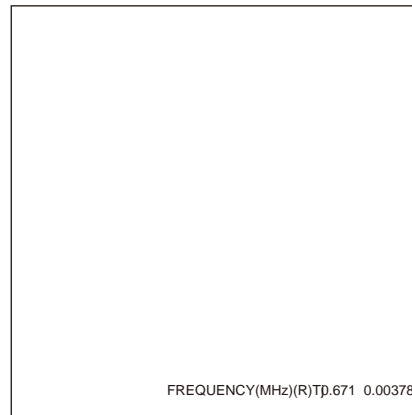
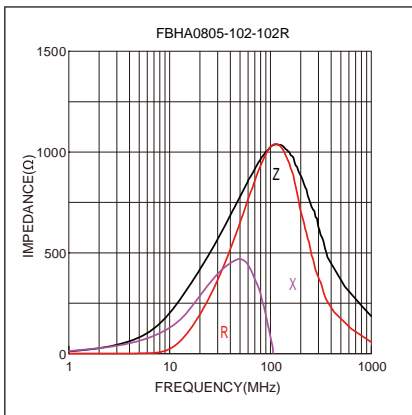
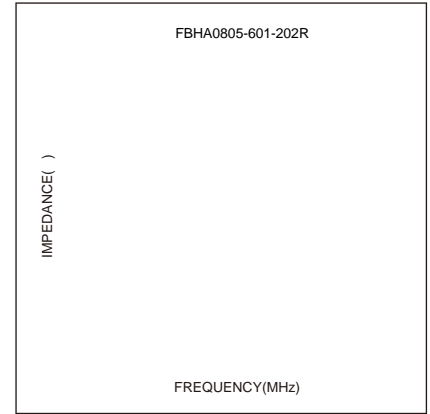
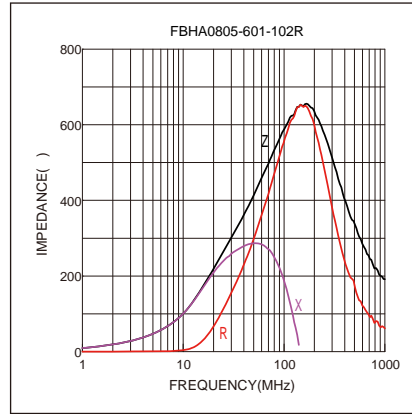
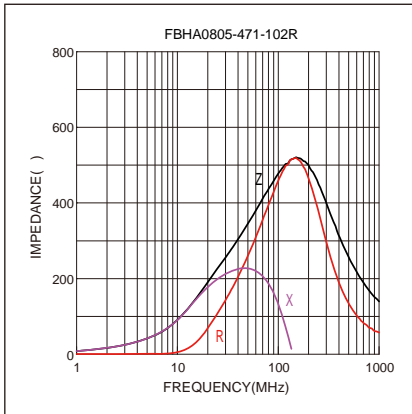



## Soldering Reflow:

## Packaging Information:

### Tape Dimension:

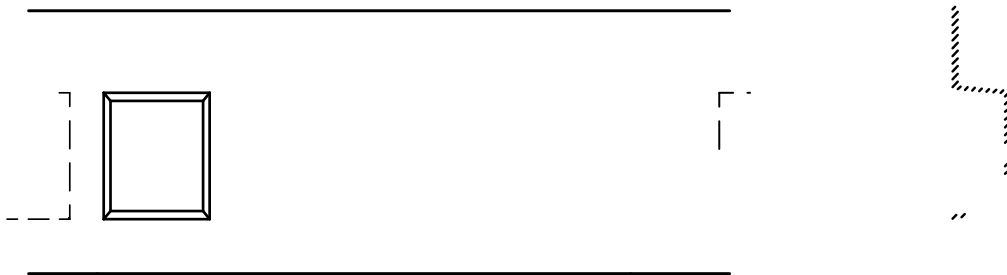

Series	A0 (mm)	B0 (mm)	D (mm)	P0 (mm)	P1 (mm)	W (mm)	K0 (mm)	E (mm)	T (mm)
FBHA0805	1.30±0.05	2.10±0.05	1.5±0.1	4.0±0.1	4.0±0.1	8.0±0.3	0.95±0.05	1.75±0.1	0.95±0.05

### Peel force of top cover tape:

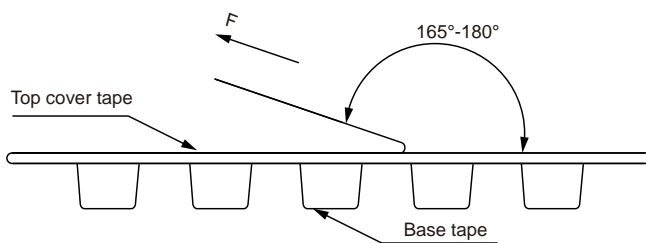

The peel force of top cover tape shall be between 0.14 to 0.58 N



## Reel Dimension: [mm]

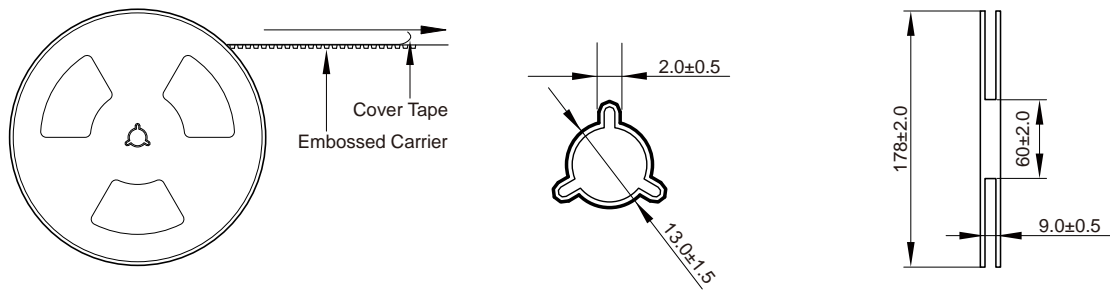

## Packaging Quantity:

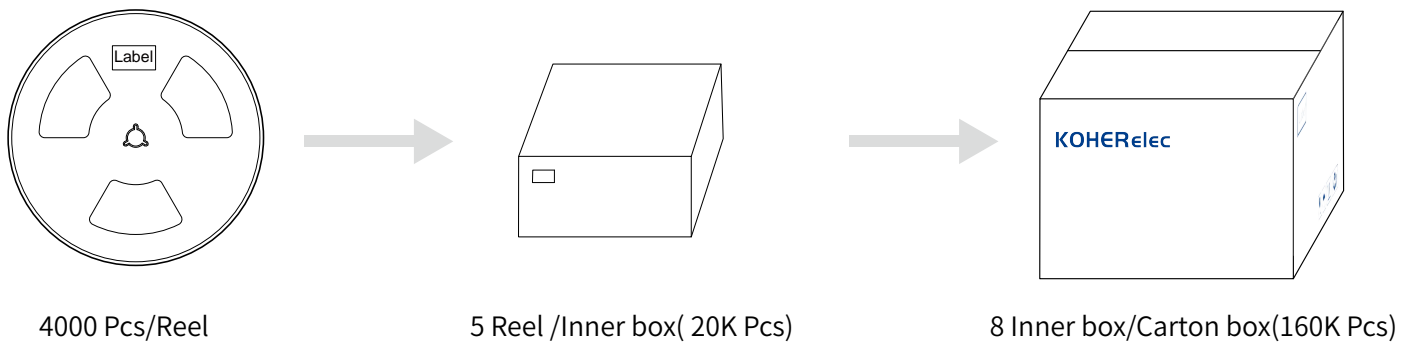

## Cautions and Warnings:

### Storage Conditions:

- The storage period is within 12 months after the completion of production. Be sure to follow the storage conditions (temperature: -5 to 35°C, humidity: 75% RH Max). If the storage period elapses, the soldering of the terminal electrodes may deteriorate. The warranty period is one year.
- Product should not be exposed to environment with high temperature, high humidity, dust, corrosive gas and etc.
- Products should be handled with care to avoid damage or contamination from perspiration and skin oils.
- Please always handle products carefully to prevent any damage caused by dropping down or inappropriate removing.

### Operation Instructions:

- Self heating (temperature increase) occurs when the power is turned ON, so the tolerance should be sufficient for the set thermal design.
- Before soldering, be sure to preheat components. The preheating temperature should be set so that the temperature difference between the solder temperature and chip temperature does not exceed 150°C.
- Soldering corrections after mounting should be within the range of the conditions determined in the specifications. If overheated, a short circuit, performance deterioration, or lifespan shortening may occur.
- Generally, Koher might not be familiar with either customer's specific application or actual requests as customer does. As a result customer shall be responsible for checking and confirming whether Koher product with the performance described in the product specification is suitable for using in customer's particular application or not.