

## BCMA Series

### Common Mode Filters For Automotive Signal Line/Power Line Size 5020

#### FEATURES

- High common mode impedance at high frequency cause excellent noise suppression performance
- Designed to be low profile and Supports large currents (up to 6 A)
- Operating temperature range: -40 to +125°C(including self-temperature rise)
- AEC-Q200 qualified
- Quantity: 2500pcs

#### APPLICATION

- Headlamps, tail lamps and interior lighting
- HVAC
- Doors, window/lift and seat control
- Audio subsystem
- Digital instrument cluster
- In-Vehicle Infotainment and navigation

#### Dimensions: [mm]

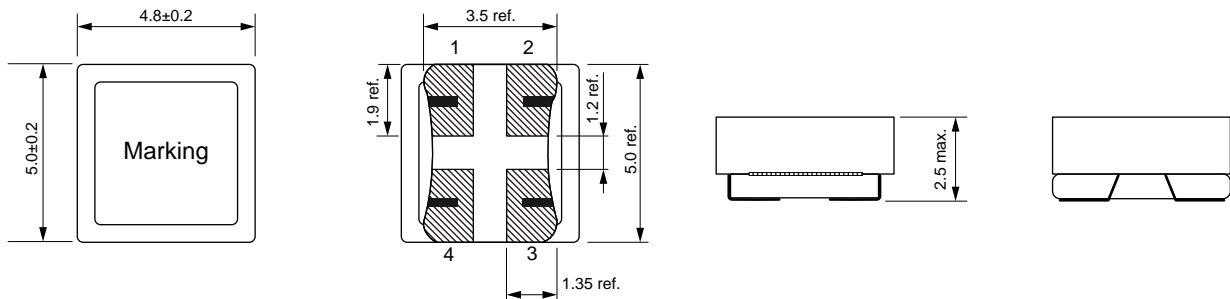

#### Schematic:

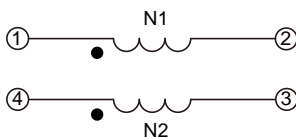

#### Land Pattern: [mm]

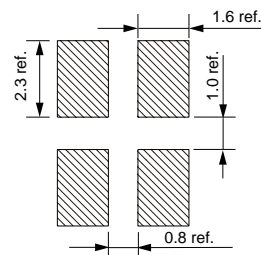

## Electrical Properties:

Part No	Z@100MHz Typ.				IR Min.
BCMA5020-101N	100	6.0	13	50	10
BCMA5020-251N	250	5.0	20	50	10
BCMA5020-501N	500	4.0	27	50	10
BCMA5020-102N	1000	2.0	34	50	10
BCMA5020-142N	1400	1.5	56	50	10
BCMA5020-152N	1500	1.5	56	50	10

Temperature Rise Current: The actual value of DC current when the temperature rise is  $\Delta T=40^{\circ}\text{C}$

## Typical Electrical Characteristics:

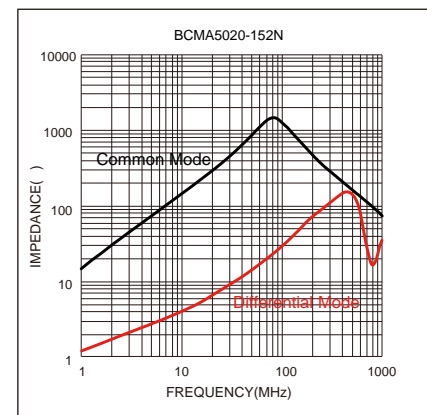
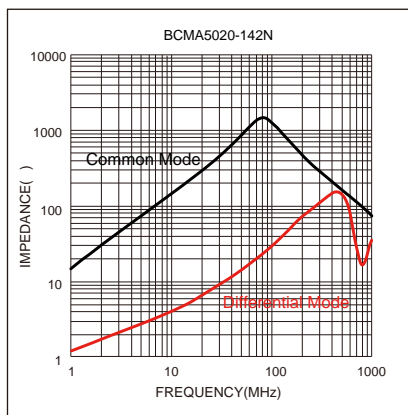
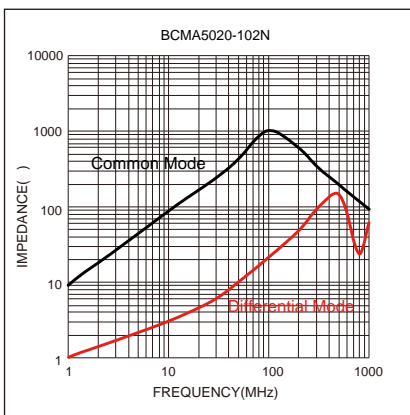
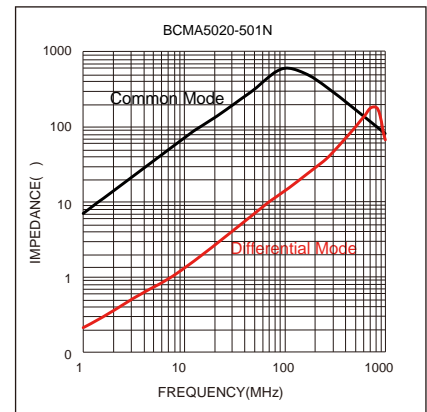
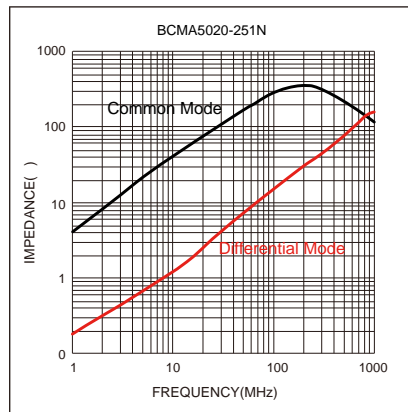
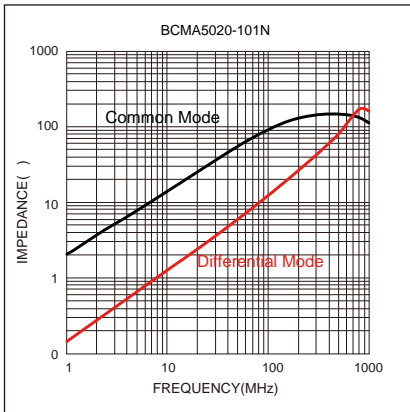

## Soldering Reflow:

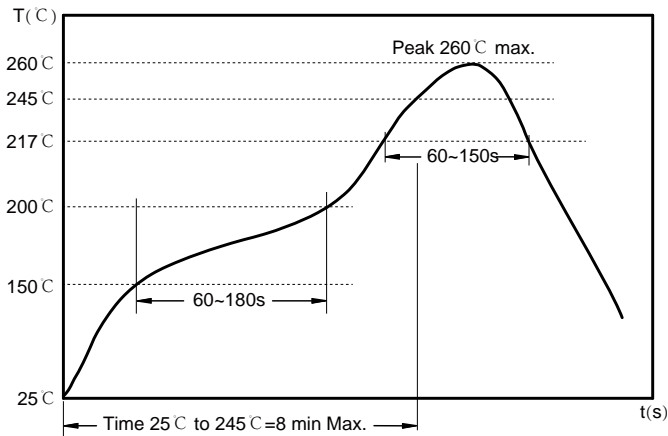

Preheat condition: 150 ~200 °C / 60~180 sec.

Allowed time above 217 °C : 60~150 sec.

Max temperature: 260 °C .

Max time at max temperature: 10 sec.

Allowed Reflow time: 3x max.

## Packaging Information:

### Tape Dimension :

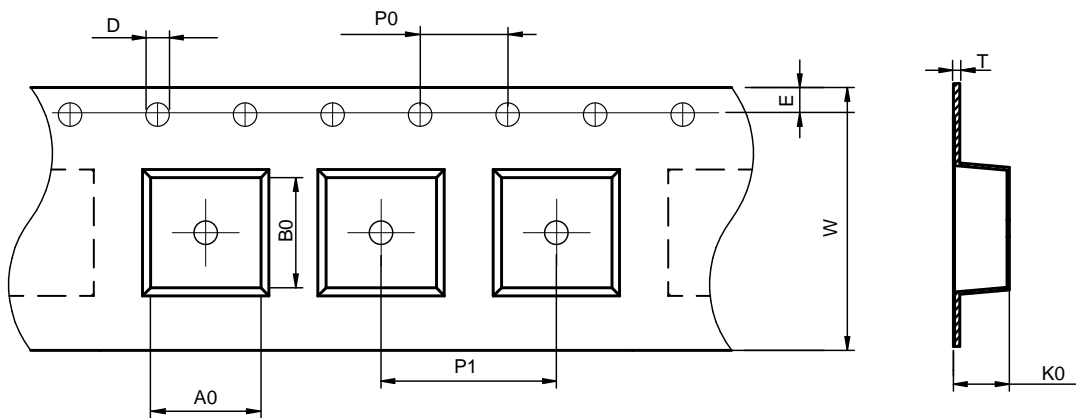

Series	A0 (mm)	B0 (mm)	D (mm)	P0 (mm)	P1 (mm)	W (mm)	K0 (mm)	E (mm)	T (mm)
BCMA5020	5.65±0.1	5.65±0.1	1.5±0.1	4.0±0.1	8.0±0.1	12.0±0.3	2.7±0.1	1.75±0.1	0.40±0.05

### Peel force of top cover tape:

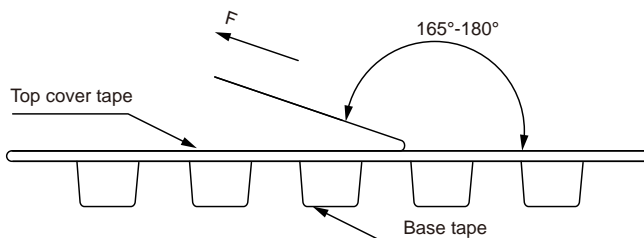

The peel force of top cover tape shall be between 0.10 to 1.17 N

### Product Marking:

Marking	Printing (Impedance)
---------	----------------------

## Reel Dimension: [mm]

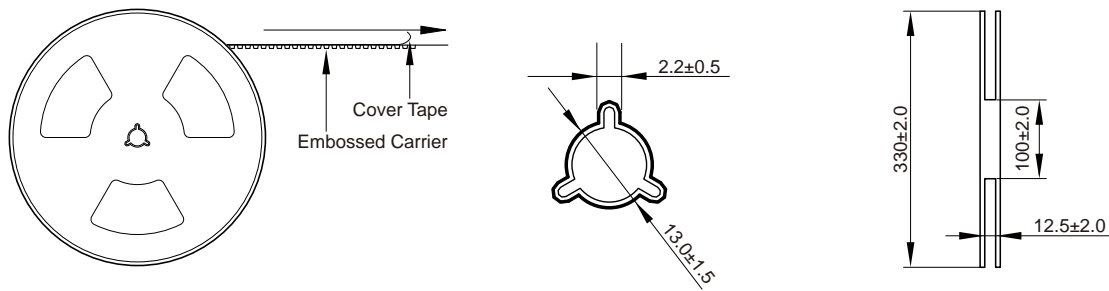

## Packaging Quantity:

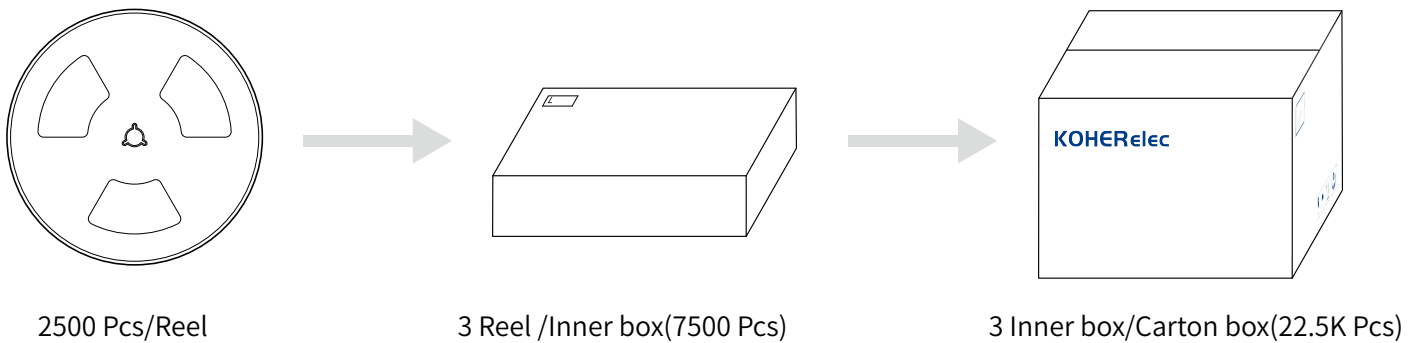

## Cautions and Warnings:

### Storage Conditions:

- The storage period is within 12 months after the completion of production. Be sure to follow the storage conditions (temperature: -5 to 35°C, humidity: 75% RH Max). If the storage period elapses, the soldering of the terminal electrodes may deteriorate. The warranty period is one year.
- Product should not be exposed to environment with high temperature, high humidity, dust, corrosive gas and etc.
- Products should be handled with care to avoid damage or contamination from perspiration and skin oils.
- Please always handle products carefully to prevent any damage caused by dropping down or inappropriate removing.

### Operation Instructions:

- Self heating (temperature increase) occurs when the power is turned ON, so the tolerance should be sufficient for the set thermal design.
- Before soldering, be sure to preheat components. The preheating temperature should be set so that the temperature difference between the solder temperature and chip temperature does not exceed 150°C.
- Soldering corrections after mounting should be within the range of the conditions determined in the specifications. If overheated, a short circuit, performance deterioration, or lifespan shortening may occur.
- Generally, Koher might not be familiar with either customer's specific application or actual requests as customer does. As a result customer shall be responsible for checking and confirming whether Koher product with the performance described in the product specification is suitable for using in customer's particular application or not.